

Chapter 17

Transient Suppressors and Surge Suppressors

We use transient suppressors and surge suppressors to protect electronic devices and circuits from overvoltages caused by:

- Lightning.
- Electrostatic discharge (ESD).
- Switching transients.
- Inductive kickback.
- Shorts and other problems in power wiring.

All transient suppressors and surge suppressors operate on the voltage-divider principle (Figure 17-1):

- A blocking device detects excessive current flow, and increases its resistance sharply to hold the load current below some limit.
- A shunting device detects excessive voltage, and switches to a low-impedance state so that the excess current goes through it, and not through the load.

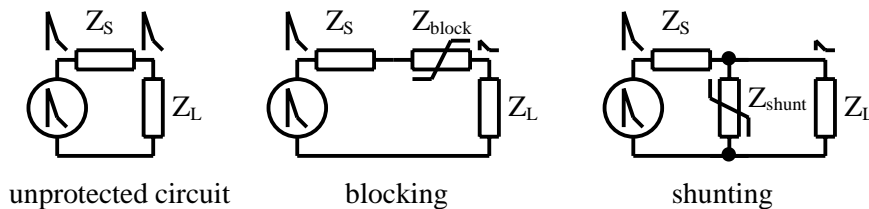

Figure 17-1. Voltage Division with Transient/Surge Protectors

Positive-temperature coefficient (PTC) resistors (Chapter 6) and constant-current diodes (Chapter 16) are non-linear devices that increase

their resistance with increasing voltage. But PTC resistors are slow, with response times of milliseconds up to seconds—neither type will survive trying to block the high-voltage, high-current transients and surges that usually concern us.

Shunting devices are a lot easier to design and build, because insulators and semiconductors breakdown under high voltage—suddenly conducting lots of current. The challenge is:

- Maintaining low leakage current until we reach the threshold voltage.
- Controlling the threshold voltage.
- Maintaining low impedance after we reach the threshold voltage.
- Returning to a low-leakage state when the transient or surge is over.
- Not destroying or degrading the device in the process.

The dividing line between transients and surges is fuzzy. We usually think of transients as being very fast, but with low total energy, such as ESD zaps and inductive kickback. We usually think of surges being slow, prolonged, and with high total energy, such as lightning strikes, or excessive AC voltage because of wiring problems. A friend lost two computers (on two separate occasions), a television set, a stereo, and a bunch of clocks when she tried to use her microwave oven, because the neutral wire to her apartment's fuse panel developed an intermittent connection (Figure 17-2). Even so she was lucky—when the electricians finally found the problem in the attic, there were scorch marks where the neutral wire had been arcing. Given time, it could have set her apartment building on fire...

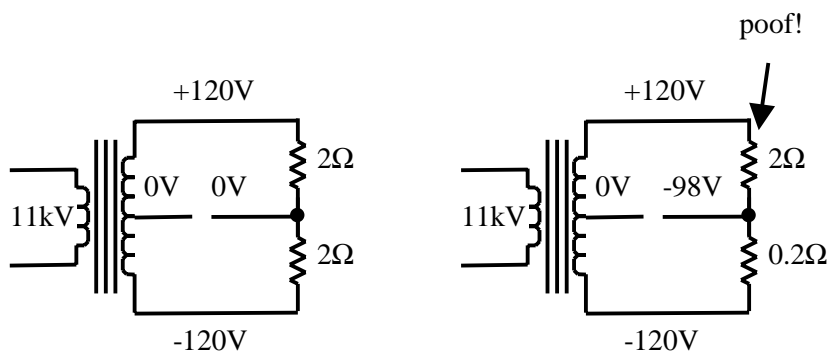

Figure 17-2. AC Surge Voltage from Open Neutral Conductor

Problems with neutrals in buildings are a lot more frequent than we might think. Electrical building codes used to permit neutrals in three-phase "Y" (star) systems to be several gages smaller than the phase wiring,

assuming that the neutral would only have to carry the unbalanced phase currents (Figure 17-3) from motors and lighting loads.

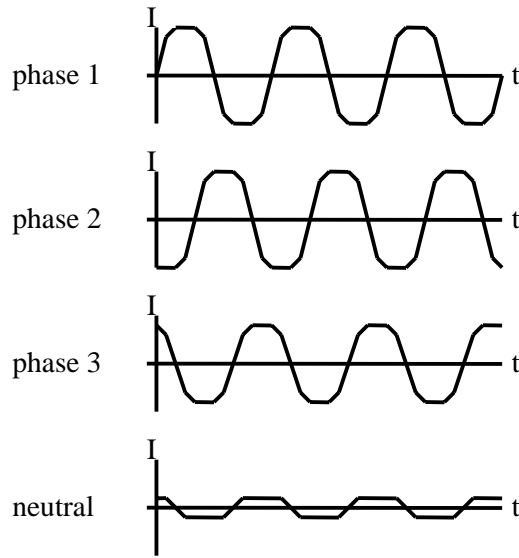

Figure 17-3. Current on Three-Phase Wiring in a Balanced System

But switching power supplies, and huge numbers of personal computers being installed in old buildings have led to numerous building fires. A non-power-factor-corrected switching power supply draws current only at the peaks of the phase voltage. If we have many of these power supplies on a three-phase "Y" (star) power system, the current on the building wiring looks more like Figure 17-4. Worst-case, the neutral wire carries the total return currents of all three phases, and may need to be oversized by several gages to keep it from overheating. Instead of requiring users to rewire their buildings, the EN 61000-3-2 harmonics standard puts the burden on the companies selling new equipment, to keep harmonic currents at a safe level.

For equipment and product design, we must expect some neutral-to-ground voltage at wall outlets (from $1V_{RMS}$ up to maybe $10V_{RMS}$), and must accommodate it when choosing transient or surge protectors. I have seen some microprocessor-controlled production equipment that had many intermittent problems until we put each unit on its own isolation transformer, to eliminate this neutral-to-ground voltage.

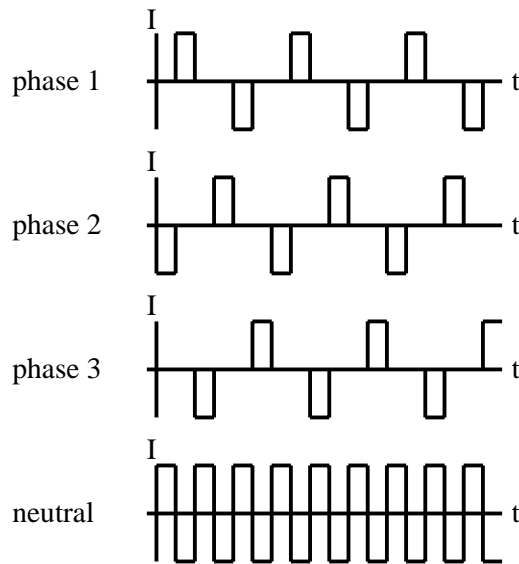

Figure 17-4. Current on Three-Phase Wiring with Many Switching Power Supplies

Some important properties of transient and surge protectors are the:

- Unidirectional or bidirectional protection.
- Clamp or Crowbar.
- Technology
- Clamp voltage (clamps).
- Nonlinearity (clamps).
- Trigger voltage (semiconductor crowbars).
- On-state voltage (semiconductor crowbars).
- Holding Current (semiconductor crowbars).
- Firing voltage (gas crowbars).
- Glow voltage (gas crowbars).
- Arc-extinguishing current (gas crowbars)
- Design tolerance.
- Surge current rating.
- Transient average power rating.
- Maximum transient energy rating.
- Response time.
- 2-terminal, feedthrough, or 4-terminal construction.
- Capacitance.
- Leakage current.
- Insulation resistance.
- Failure modes.
- Safety agency approvals.
- Footprint.

- Height.
- Operating temperature range and derating curve.
- Storage temperature range.
- Maximum soldering temperature and duration.
- Thermal resistance, in degrees Celsius per watt.
- Lifetime.
- Cost.
- Availability.
- Multiple sources.

Our first concern is whether we need protection against just one polarity of transients/surges (unidirectional), or against both polarities (bidirectional). Some transient and surge suppressors are inherently bidirectional. Depending on their V-I curves, we can use two unidirectional suppressors against bidirectional threats by putting them either in reverse series or anti-parallel (Figure 17-5).

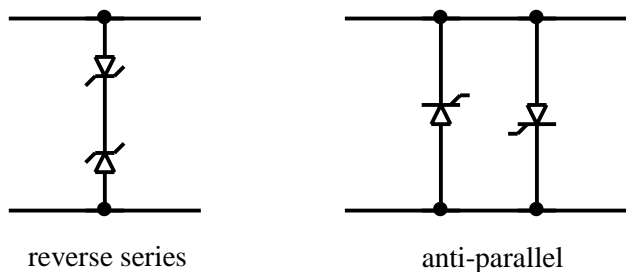

Figure 17-5. Pairing Unidirectional Suppressors for Protection from Bidirectional Threats

The two main families of transient/surge protectors are:

- Clamps (Zener diodes, varistors, and the like).
- Crowbars (SIDACTors®, SURGECTOR's™).

Clamps (Figures 17-6 and 17-7) have no memory, so they:

- Return to the low-leakage state as soon as the overvoltage is removed.
- Lop just the tops off of transient pulses and surge voltages (Figure 17-8)— so the device(s) they are supposed to protect are exposed to the full clamp voltage for the duration of the transient/surge.
- Are limited by their maximum power dissipation.

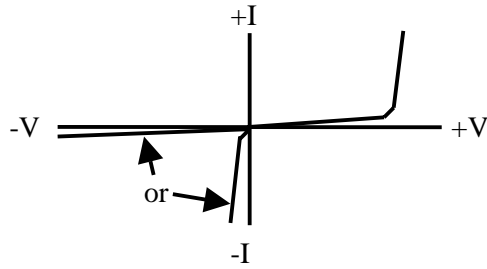

Figure 17-6. Typical V-I Curve for a Unidirectional Clamp

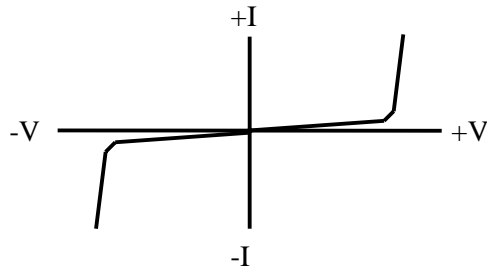

Figure 17-7. Typical V-I Curve for a Bidirectional Clamp

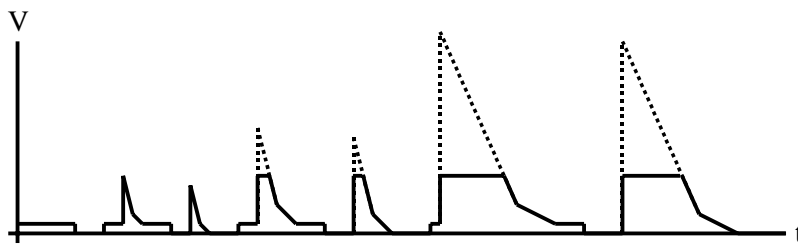

Figure 17-8. Clamp Action on Transients/Surges

Crowbars (Figures 17-9 and 17-10) have memory, so they:

- Usually are slower to react than clamps.
- Short out transient pulses and surge voltages (Figure 17-11)— so the device(s) they are supposed to protect are only exposed to the full breakdown voltage for the protector's response time.
- Only return to their low-leakage state after the current through them has fallen below their hold current, or something else resets them.
- Usually have higher current ratings than clamps of the same size.
- Usually have less parasitic capacitance than clamps of the same size.

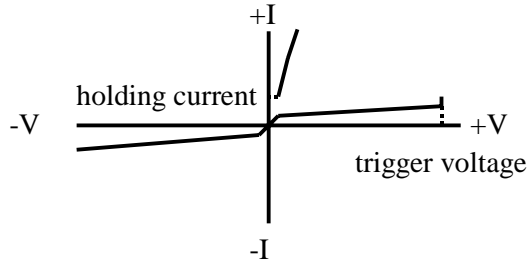

Figure 17-9. Typical V-I Curve for a Unidirectional Crowbar

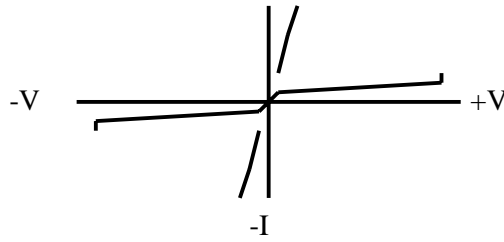

Figure 17-10. Typical V-I Curve for a Bidirectional Crowbar

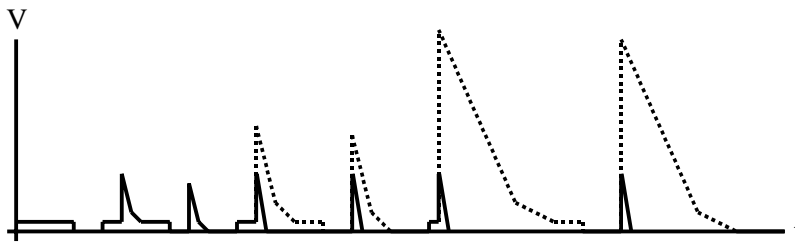

Figure 17-11. Crowbar Action on Transients/Surges

Some common unidirectional clamps are:

- Zener diodes or avalanche diodes to ground.
- Silicon avalanche suppressors (Transzorbs®) to ground.

Zener or avalanche diodes are more nonlinear, and have a better clamping ratio than metal-oxide varistors (MOV's) or multilayer varistors (MLV's)—but they are more susceptible to damage for a given physical size. We can use diodes in series with them to reduce the parasitic capacitance.

Silicon avalanche suppressors are Zener or avalanche diodes with very-large junctions, designed to handle high-power, high-energy transients and surges.

Some common bidirectional clamps are:

- Metal-oxide varistors (MOV's) to ground.
- Multifunction capacitors (MFC's) to ground.
- Multilayer varistors (MLV's, TransGuards® are one brand) to ground.
- Reverse-biased diodes to power and ground.
- Silicon carbide (SiC) varistors to ground.
- TransFeed varistors to ground.

Metal-oxide varistors (MOV's) are usually made of zinc oxide, and have high capacitance. Each grain boundary has a clamp voltage of about 2 volts, so low-voltage MOV's must either be very thin, or have very large grains. If we include a MOV(s) across primary power inside our equipment, we should include a label with its(their) characteristics to that external surge protection can be coordinated with it.

Multifunction capacitors (MFC's) are capacitors that use a varistor-type material as the dielectric—if an overvoltage is applied, they act like a metal-oxide varistor or multilayer varistor.

Multilayer varistors (MLV's) have many sets of plates with very thin layers of a varistor material. Thus they can achieve very low clamp voltages at high currents while still being physically tough.

Reverse-biased diodes to power and ground form a major part of the electrostatic-discharge-protection circuits inside many integrated circuits. Paired diodes are readily available in SOT-23 packages for protecting connector pins. We want to include a 100 to 200nF capacitor between power and ground close to these diodes, to reduce the impedance of the power net.

Silicon carbide varistors are an older version of metal-oxide varistors. They are still used to protect power lines from lightning strikes, in series with spark gaps.

TransFeed® varistors are three-terminal multilayer varistors, made with a feedthrough-capacitor construction. The signal goes through the device, and ground attaches to pads at the center, to provide very low inductance and sub-nanosecond response times.

Some common unidirectional crowbar devices are:

- SIDACTors® to ground.
- SURGECTOR's™ to ground.

SIDACtors® are thyristors with an overvoltage trigger built in, and can be designed to crowbar unidirectional or bidirectional transients/surges.

SURGECTOR's™ are thyristors with Zener diodes integrated into them to crowbar unidirectional or bidirectional transients/surges.

Some common bidirectional crowbar devices are:

- Gas-tube arrestors to ground.
- SIDACtors® to ground.
- Spark gaps to ground.
- SURGECTOR's® to ground.

Gas-tube arrestors have argon, krypton, neon, or another gas that ionizes easily, contained in a sealed chamber for protection from atmospheric contamination. The trigger voltage can be adjusted by the spacing of the plates and the gas pressure. If air leaks into the tube, the trigger voltage can increase up to 20 times over the intended trigger voltage. Once they fire, the voltage across the gap will be only about 10-30V, so they can handle very-high currents. They have low capacitance, and are made in two-element and three-element versions. We use the three-element versions with differential lines, such as phone lines, to ensure that both lines crowbar if the voltage get high enough to fire the device. Otherwise, a common-mode transient can be converted to a differential-mode transient if only one of a pair of two-element protectors fires. Some gas-tube arrestors contain a small amount of radioactive material to maintain a slight level of ionization inside the gas chamber to speed up their response time. Gas tubes may fire accidentally if they are exposed to high radio-frequency fields. "Fail safe" (fail short) gas tube arrestors contain a low-melting point metal, so if they arc for a prolonged period they will short out.

SIDACtors® are thyristors with an overvoltage trigger built in, and can be designed to crowbar unidirectional or bidirectional transients/surges.

Spark gaps are simple, reliable, cheap, and have low capacitance—but the voltage at which they fire is dependent on the dv/dt of the transient and atmospheric contamination of the points. Once they fire, the voltage across the gap will be only about 10-20V, so they can handle very-high currents.

To turn off gas-tube arrestors or spark gaps, we must drop the current below the arc-extinguishing current

SURGECTOR's™ are thyristors with Zener diodes integrated into them to crowbar unidirectional or bidirectional transients/surges.

Hybrid transient/surge protectors combine a crowbar with a clamp, or a clamp/crowbar with a filter, in one module. Because so many combinations are possible, we must refer to the specific device's datasheet.

The clamp voltage is the voltage across a clamp, at a specified surge current. The minimum clamp voltage should be chosen to be above the maximum peak signal voltage by 8 to 10% or so.

The nonlinearity of a clamp (Table 17-1) is the exponent of the voltage, x , in the equation

$$I = KV^x \text{ amperes}$$

where:

- I is the current through the clamp, in amperes.
- K is a constant depending on the device, in amperes/volt ^{x} .
- x is the non-linearity.

The trigger voltage is the voltage needed to trigger a semiconductor crowbar into conduction. The minimum trigger voltage should be chosen to be above the maximum peak signal voltage by 8 to 10% or so.

The on-state voltage is the voltage across a semiconductor crowbar once it has been triggered into conduction, at a specified surge current.

The holding current is the minimum current required to keep a semiconductor crowbar in its on state.

Gas-tube arrestors and spark gaps have a firing voltage to establish the arc. Paschen's Law gives the minimum firing voltage for various gases as a function of the gas pressure. The minimum firing voltage should be chosen to be above the maximum peak signal voltage by 8 to 10% or so.

Once we have established the arc, the voltage across a gas-tube arrestor or spark gap will drop to the glow voltage.

Table 17-1. Transient Protector and Surge Protector Technologies

Technology	Threshold Voltage, in V	Surge Current Rating, in A	Response time, in s	Capacitance, in F	Nonlinearity, $I = K V^x$
Avalanche Diodes	1→700	1→500	<1→25	2E-12→60,000E-12	30→700
Diodes					
Gas-Tube Arrestors	70→40,000	800→20,000	50E-9→5,000E-9	0.5E-12→10E-12	—
Multifunction Capacitors					
Multilayer Varistors	3.5→275	100→500		30E-12→6,00E-12	
Metal-Oxide Varistors	4→6,000	10→100,000	<1E-9→50E-9	10E-12→33,000E-12	15→100
Silicon Carbide Varistors	7→1,500	1→1,000	300E-9→10,000E-9	30E-12→4,000E-12	2→7
SIDACtors®	27→540	50→3,000		25E-12→200E-12	—
Silicon Avalanche Suppressors	5→500	2→2,000	<1E-9→10E-9	10E-12→90,000E-12	≈35
Spark Gaps	90→1,400				
SURGECTORS	5→600	5→3,500	<1E-9→10,000E-9	50E-12→200E-12	—
TransFeed Varistors			0.2E-9→0.25E-9		
TransGuards	4→83	20→300	0.5E-9→	3E-12→5,500E-12	
Transzorbs	6→500	2→2,000	<1E-9→10E-9	10E-12→90,000E-12	≈35
Zener Diodes	1→700	1→500	<1E-9→25E-9	2E-12→60,000E-12	7→100

To quench the arc we must drop the voltage below 20V, and the current below the arc-extinguishing current. If the electrodes are hot, the zero-crossings of 60Hz AC may not last long enough to quench the arc. For DC circuits, we may have trouble quenching the arc if the power supply provides over 15V and over 50mA. A glow discharge may persist if more than 10μA is available at over 50 to 100V, and can eventually damage the gas-tube arrester or spark gap by sputtering. To prevent this:

- The normal system voltage of DC sources should be less than 50V.
- The peak voltage of AC sources should be less than the firing voltage.

The design tolerance is the percentage tolerance on the:

- Clamp voltage of a clamp.
- Trigger voltage of a semiconductor crowbar.
- Firing voltage of a gas-tube arrester or spark gap.

The surge current rating is the maximum current in amperes that a clamp or crowbar can carry, when it is conducting.

The transient average power rating is the maximum average power in watts that the transient/surge protector can absorb from one, or a burst of pulses, during a specified time period.

The maximum transient energy rating is the maximum energy in joules that the transient/surge protector can absorb from one or a burst of pulses.

The response time of a clamp or crowbar is the time in seconds it takes a transient/surge protector to turn on and start conducting current. The response time we measure in a circuit depends strongly on the inductance between the wires we are shunting and the clamp/crowbar.

Even a few nanohenries of parasitic inductance present a high impedance to fast-rising voltages. This impedance delays the voltage reaching the clamp/crowbar, slowing down its response to the transient by nanoseconds. With 2-terminal clamps/crowbars we want to bring the signal and ground connections directly to the device, then go to the device we are protecting. 4-terminal construction routes both signal and ground through the clamp/crowbar (Figure 17-12). Feedthrough construction (TransFeed® varistors) routes the signal through the clamp/crowbar, with ground connections to the middle of the device.

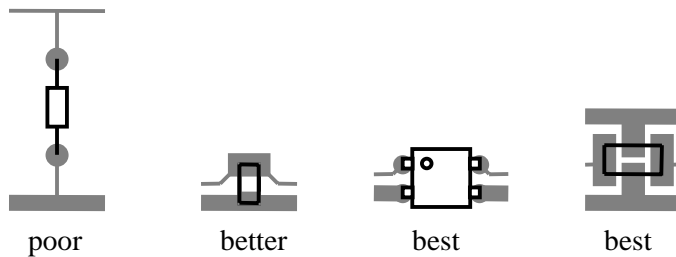

Figure 17-12. Connecting Signal and Ground to a Transient/Surge Protector

Some signals, such as high-speed data lines, may require the capacitance of the transient/surge protectors to be very low.

Some signals may require the leakage current through the transient/surge protectors to be very low, until we reach the threshold voltage.

The insulation resistance is the minimum resistance in ohms between the terminals of the device shorted together, and the surface of the case. Safety

agencies treat the cases of MOV's as conductive surfaces. If a MOV can lean over, reducing the primary-to-secondary creepage or clearance below the specified minimums, we must:

- Secure the MOV so it can't move.
OR
- Put a sufficiently large-and-thick piece of heat-shrink tubing over the MOV, to guarantee the required creepage and clearance even if it leans against other parts.

Transient and surge protectors usually fail by shorting. About 1990, some of the Nordic countries required any MOV's across primary power to be protected by a high-break-capacity (1500A) fuse, whereas primary transformers only had to be protected by a low-break-capacity (35A) fuse. But if the energy in the transient or surge is great enough, the transient/surge protector will melt or blow itself apart, failing open. MOV's should not be used in applications where they will get hit by repetitive transients/surges. Their clamp voltage decreases a little bit with each hit they absorb. Then, when their clamp voltage finally reaches the peak voltage of the input power, they will quickly self-destruct.

Transient and surge protectors placed across primary AC power will need safety agency approvals. Salespeople are much more motivated to provide the device's yellow card, and other safety certificates, if we request them before we have designed their transient/surge protector into our product.

The footprint of a transient/surge suppressor is its length, width, and shape.

The height of a transient/surge suppressor is how far it sticks above the supporting surface.

The operating temperature range is the range of ambient temperatures over which the transient/surge suppressor may be used without derating. Above the maximum temperature, both energy and power must be reduced.

MIL-HDBK-1547A recommends derating transient suppressors to (operating them at no more than):

- 75% of their rated power.
- 75% of their transient current.
- 70% of their clamp voltage.
- 80% of their maximum junction temperature, in degrees Celsius.

The storage temperature range is the permissible range of ambient temperature without voltage or pulses applied.

The materials and construction of transient/surge suppressors set a maximum soldering temperature, and total duration, that may be used in manufacturing, rework, and repair.

The thermal resistance is the temperature difference between two points, such as the junction and the case, or the junction and ambient air, divided by the number of watts being dissipated by the device. It is specified in degrees Celsius per watt.

The lifetime of a transient/surge suppressor is the number of transients/surges of a specified voltage, risetime, and duration it can survive, before the threshold voltage changes by more than a specified amount.

Purchasing likes to:

- Buy transient/surge suppressors at reasonable prices.
- Get them within a reasonable leadtime.
- Have at least two qualified sources if possible.

Books

- Applications Guide to EMI, RFI, ESD Solutions*. AVX, pp. 4, 6, 16→18.
- Designing for Immunity to Pulsed EMI*. Wilmington, MA: KeyTek, 1990, pp. 36→47.
- Electromagnetic Pulse Handbook for Missiles and Aircraft in Flight EMP Interaction 1-1*. Air Force Weapons Laboratory, September 1972, pp. 351→355.
- Electrostatic Discharge (ESD) Protection Test Handbook, 2nd Edition*. Burlington, MA: Keytek, 1986, pp. 30, 31.
- Handbook of EC EMC Compliance*. Boxborough, MA: Compliance Design, 1993, pp. 59, 60.
- Optoelectronics/Fiber-Optics Applications Manual, 2nd Edition*. New York: McGraw-Hill, 1981, pp. 13.6.
- Power Applications Manual*. Motorola, 1993, pp. 21, 22, 29→34.
- Surge Protection Test Handbook*. Burlington, MA: KeyTek, , 1982, pp. 26→30.
- Transient Voltage Suppression Manual, 2nd Edition*. Schenectady, NY: General Electric, 1976, pp. 16→18, 23→107.
- Zener Diode Handbook*. Phoenix, AZ: Motorola Semiconductor Products, 1967, pp. 7-1→7-15.
- Barnes, John R., *Electronic System Design: Interference and Noise Control Techniques*. Englewood Cliffs, NJ: Prentice Hall, 1987, pp. 70, 71.
- Billings, Keith, *Switchmode Power Supply Handbook*. New York: McGraw-Hill, 1989, pp. 1.22→1.26.
- Cobine, James Dillon, *Gaseous Conductors: Theory and Engineering Applications*. New York: McGraw-Hill, 1941, pp. 163→196, 205→281.
- Frydenlund, Marvin M., *Lightning Protection for People and Property*. New York: Van Nostrand Reinhold, 1993, pp. 179→186.

- Giacoletto, L. J., *Electronics Designers' Handbook, 2nd Edition*. New York: McGraw-Hill, 1977, pp. 10-8→10-10.
- Gibilisco, Stan, *Electronics Portable Handbook*. New York: McGraw-Hill, 2000, pp. 148.
- Ginsberg, Gerald L., *A User's Guide to Selecting Electronic Components*. New York: John Wiley & Sons, 1981, pp. 236, 237.
- Goedblood, Jasper, *Electromagnetic Compatibility*. New York: Prentice Hall, 1990, pp. 319→322.
- Graf, Rudolf F., *Electronic Databook, 3rd Edition*. Blue Ridge Summit: TAB Books, 1983, pp. 163.
- Hart, William C., and Malone, Edgar W., *Lightning and Lightning Protection*. Gainesville, VA: Don White Consultants, 1988, pp. 3.46→3.66.
- Hartal, Oren, *Electromagnetic Compatibility by Design, 4th Edition*. West Conshohocken, PA: R & B Enterprises, 1996, pp. 324→330.
- Hasse, Peter, *Overvoltage Protection of Low Voltage Systems, 2nd Edition*. London: Institution of Electrical Engineers, 2000, pp. 153→178.
- Henney, Keith, *Radio Engineering Handbook*. New York: McGraw-Hill, 1950, pp. 107→108.
- Jones, Thomas H., *Electronic Components Handbook*. Reston, VA: Reston Publishing, 1978, pp. 176→181.
- Mantell, Charles L., *Engineering Materials Handbook*. New York: McGraw-Hill, 1958, pp. 19-49→19-50.
- Mardiguian, Michel, *Cookbook of EMI Fixes*. Gainesville, VA: ICT, 1989, pp. 70→74.
- Mardiguian, Michel, *Electromagnetic Control in Components and Devices*. Gainesville, VA: Interference Control Technologies, 1988, pp. 7.1→7.19.
- Mardiguian, Michel, *EMI Troubleshooting Techniques*. New York: McGraw-Hill, 2000, pp. 191→201.
- Mardiguian, Michel, *Interference Control in Computers and Microprocessor-Based Equipment*. Gainesville, VA: Don White Consultants, 1984, pp. 6.13.
- O'Hara, Martin, *EMC at Component and PCB Level*. Boston, MA: Newnes, 1998, pp. 59, 60.
- Rand, Ken R., *Lightning Protection & Grounding Solutions for Communications Sites*. Minden, NV: PolyPhase, 2000, pp. 58→63.
- Scott, John, and Van Zyl, Clinton, *Introduction to EMC*. Oxford, UK: Newnes, 1997, pp. 113→116.
- Standler, Ronald B., *Protection of Electronic Circuits from Overvoltages*. New York: John Wiley & Sons, 1989, pp. 117→170, 286→300.
- Tihanyi, Laszlo, *Electromagnetic Compatibility in Power Electronics*. New York: IEEE Press, 1995, pp. 373→378.
- Violette, J. L. Norman, *Noise Control & Design Considerations in High Performance Electronic Circuits & Systems*. Falls Church, VA: Violette Engineering, 1993, pp. 355→367.
- Waller, Mark, *PC Power Protection*. Indianapolis, IN: Howard W. Sams, 1989, pp. 103→126.
- Weston, David A., *Electromagnetic Compatibility: Principles and Applications*. New York: Marcel Dekker, 1991, pp. 284→294.
- Whitaker, Jerry C., *The Resource Book of Electronics*. New York: CRC Press, 2001, pp. 247.
- Williams, Tim, *EMC for Product Designers, 2nd Edition*. Oxford, UK: 1996, pp. 228→231.
- Zandman, Felix, Simon, Paul-Rene, and Szwarc, Joseph, *Resistor Theory and Technology*. Mendham, NJ: SciTech Publishing, 2001, pp. 247→254.

Standards

MIL-HDBK-1547A, *Electronic Parts, Materials, and Processes for Space and Launch Vehicles*. Department of Defense, 06 July 1998, pp. 75.

Catalogs

AVX 2000 Short Form Catalog. AVX, pp. 100→111.
Carborundum Varistors. Niagara Falls, NY: Carborundum, 1973, pp. 1→12.
DC Signal Line Filters for Printed Circuit Board Applications. Trenton, Ontario, Canada: muRata Erie, 1990, pp. 30→32.
EMC Components '95. Chicago, IL: Taiyo Yuden, 1995, pp. 47→51.
EMI Filter/Chip Inductor Catalog. Smyrna, GA: muRata, 1995, pp. 61→64.
EMI/RFI Filter Catalog. Smyrna, GA: muRata Erie, 1993, pp. 38→42, 75.
EMI/RFI Filters for Printed Circuit Board Application. Trenton, Ontario, Canada: muRata Erie, 1985, pp. 26→29.
Full Line Product Catalog. Malvern, PA: Vishay, 2002, pp. 301→304.
General Catalog. Irving, TX: Teccor, pp. 10→12, 75→93.
MuRata Products. Smyrna, GA: muRata, 2001, pp. 252→254.
Protek Devices Short Form Catalog. Tempe, AZ: Protek Devices, pp. 3→15.
Semiconductor Data Handbook, 3rd Edition. Syracuse, NY: General Electric, 1977, pp. 158→162, 545, 546.
SIDACTor® Data Book. Irving, TX: Teccor Electronics, pp. iv→5-10.
Signal Conditioning Products Group. AMP.
Transshield™ Surge Suppressors. Vandalia, OH: Ledex.
Transient Voltage Suppression Devices. Melbourne, FL: Harris Semiconductor, 1994, pp. 2-1→12-63.
Transient Voltage Suppression Products Catalog, 6th Edition. Newbury Park, CA: Semtech, pp. 9→174.
TVS/Zener Device Data. Phoenix, AZ: Motorola, 1994, pp. 3-1→11-32, 11-43→11-52, 11-62→11-95, 11-101→11-125.
Varistors, Thermistors and Sensors. Philips, 1992, pp. 295→348.

Papers and Articles

Foster, Julian, "Breakover diodes for transient suppression," *Electronic Engineering*, vol. 59 no. 728, pp. 35-39, August 1987.
 Korn, Sebald R., "Surface Mount Varistors," *Surface Mount Technology*, pp. 11-14, August 1986.
 Toal, F. J., Dougherty, J. P., and Randall, C. A., "Integrated Varistor-Capacitor Ceramics," *Proceedings of the Tenth IEEE International Symposium on Applications of Ferroelectrics, Volume II*, East Brunswick, NJ, August 18-21, 1996, pp. 593-596.
 Yodogawa, Masatada, "Zinc Oxide Varistors Provide Urgent Surge Control," *JEE*, vol. 24 no. 248, pp. 76-81, August 1987.

Web Pages

"The Feedthrough Varistor a New Weapon Against EMI." download from <http://www.avxcorp.com/docs/techinfo/fdtruvar.pdf>
 Harford, J. Rudy, "Surge Suppressors: How Efficient Are They?" download from http://www.rbitem.com/ArchivedArticles/lightning_and_transients/I97art14.htm